

Flexibility in Energy Systems

1 November 2019, New Delhi

Dr. Oliver Then

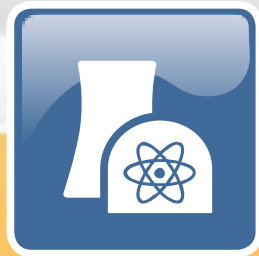



1. **About VGB**
2. Major Trends in Global Energy Systems
3. Status of Thermal Power Plants in Europe
4. Flexibility through Sector Coupling
5. Conclusions



Our mission is...

...to support our members in their operational business.

...to support our members in strategic challenges.

...to be a key contact for international energy stakeholders.

- We have **437 members** in **33 countries**, over 90% are European based
- We represent an installed capacity of **302 GW** based on renewable and conventional energy sources.

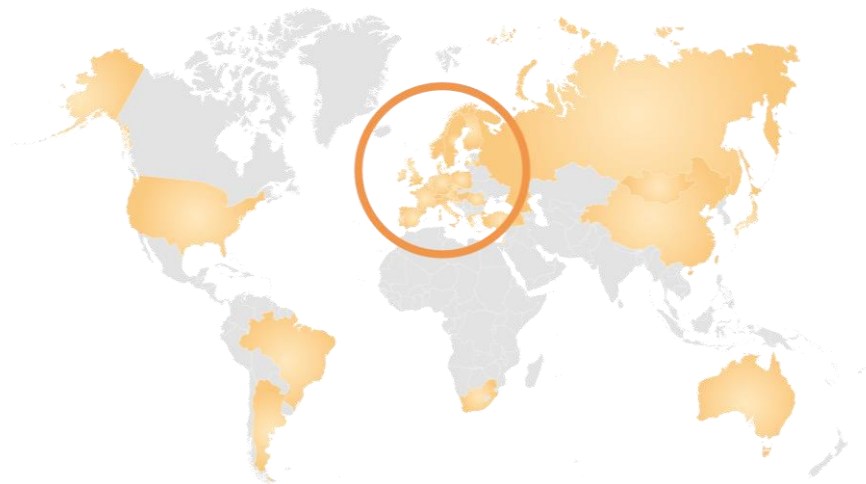

VGB is the International Technical Association for Heat and Power generation and storage. Founded in 1920 it is based on a voluntary association of companies active in the energy business.

Over 1.700 experts are active in the VGB network.

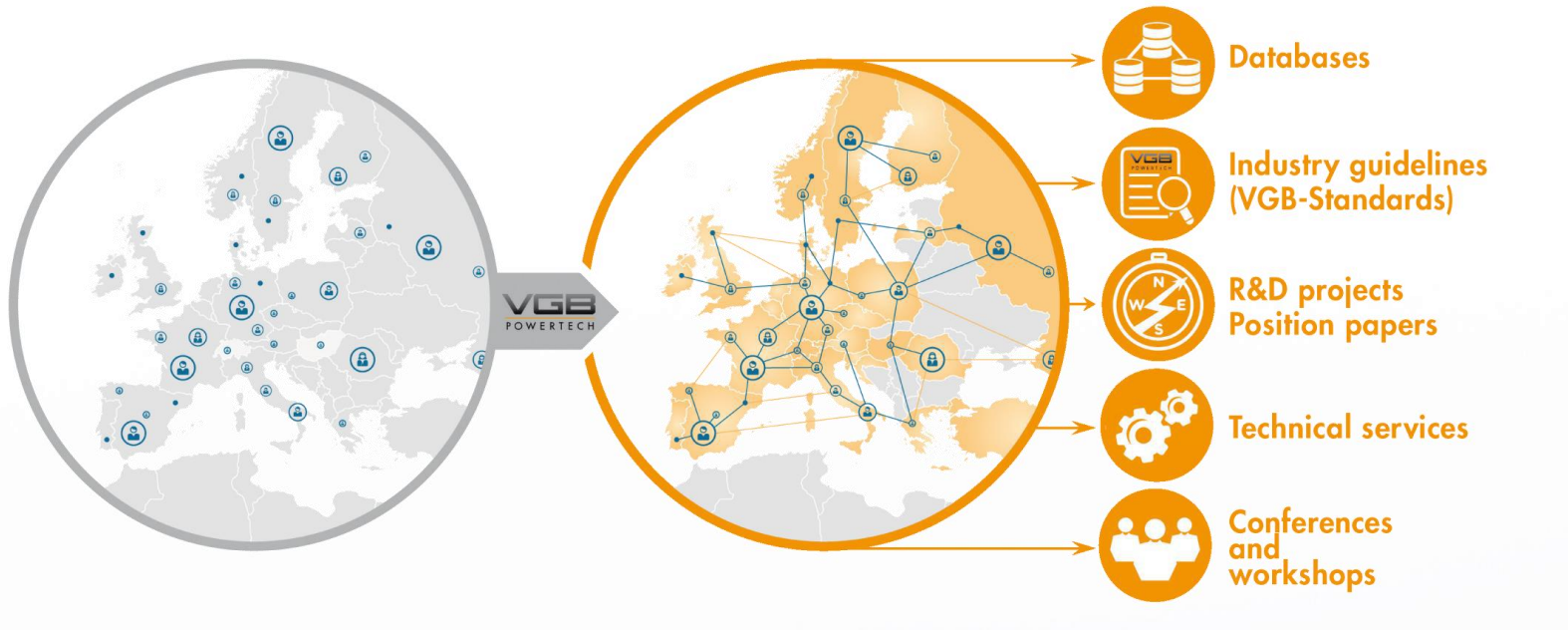

VGB facilitates the exchange of experiences between the experts and document and disseminate the results for the benefit of all members.

1. Recent Cooperation: AUSC Peer Review on Water Chemistry

- VGB and partners executed a peer review on the water chemistry concept for the Indian AUSC plant
- Close interaction with AUSC research consortia: BHEL, IGCAR (Indira Gandhi Centre of Atomic Research) and NTPC via several meetings and dozens of video conferences
- Site tour including visits at GKM Mannheim, Eemshaven power plant and several laboratories in August 2019
- Review backed up by a comprehensive technical dossier



1. Impression of the Project Activities



We are very grateful for the excellent cooperation with AUSC partners
IGCAR, BHEL and NTPC.



1. About VGB
2. **Major Trends in Global Energy Systems**
3. Status of Thermal Power Plants in Europe
4. Flexibility through Sector Coupling
5. Conclusions

1 The share of variable renewable energy (VRE) is raising around the globe.

2 Energy system flexibility becomes key to ensure efficient VRE integration and security of supply.

3 Conventional power generation is the main flexibility source – other technologies need further development.

4 Energy transition drives cross sector technologies (sector coupling) such as Power-to-x.

5 The market design is a key for an efficient energy system transformation.

2. The need for flexibility: example Germany

VGB study 2018: Secure capacity of wind in the EU is about 4%.

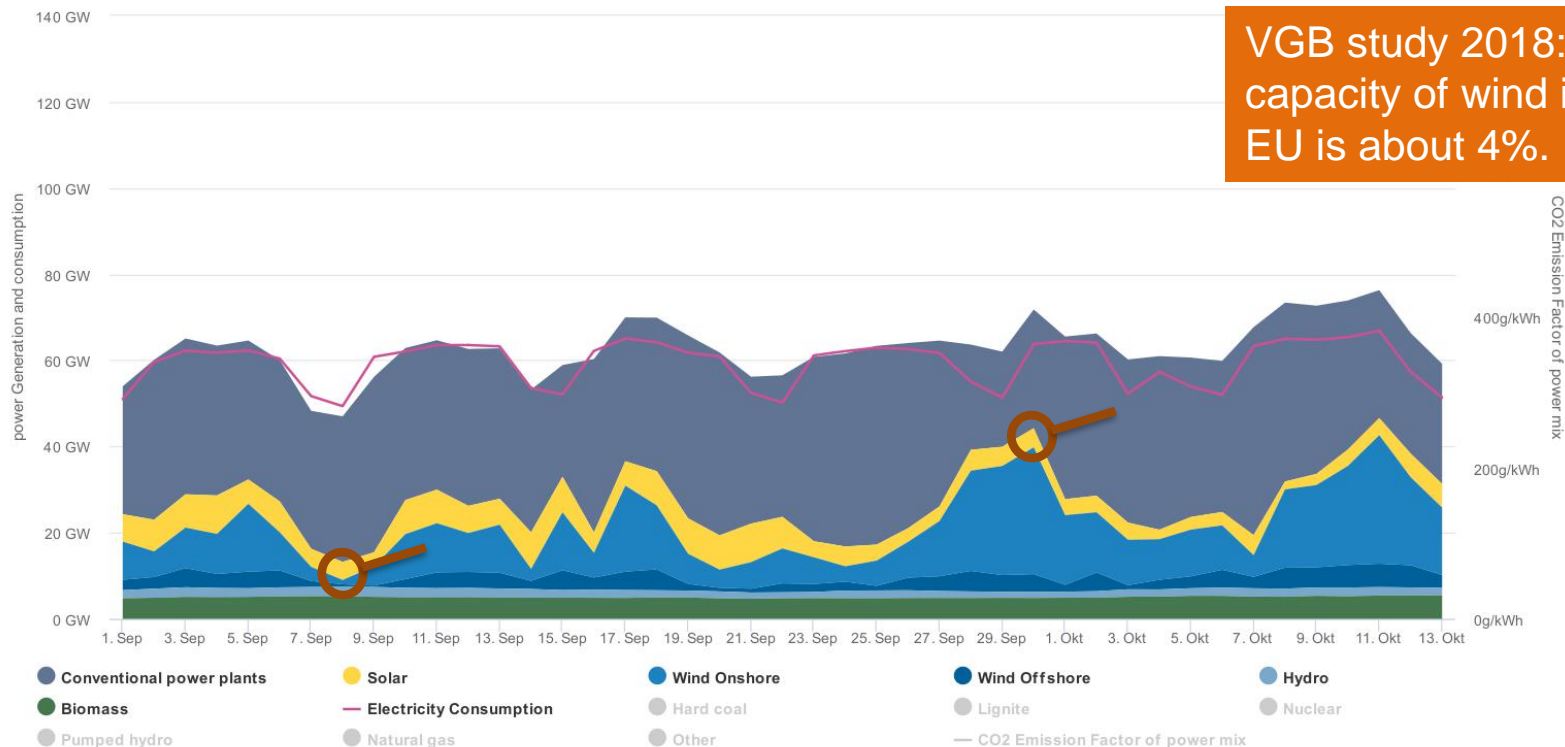

Generation portfolio in GW, Germany, September/October 2019

Agora Energiewende, Current to: 14.10.2019, 13:30

2. Future Energy System: Flexibility options

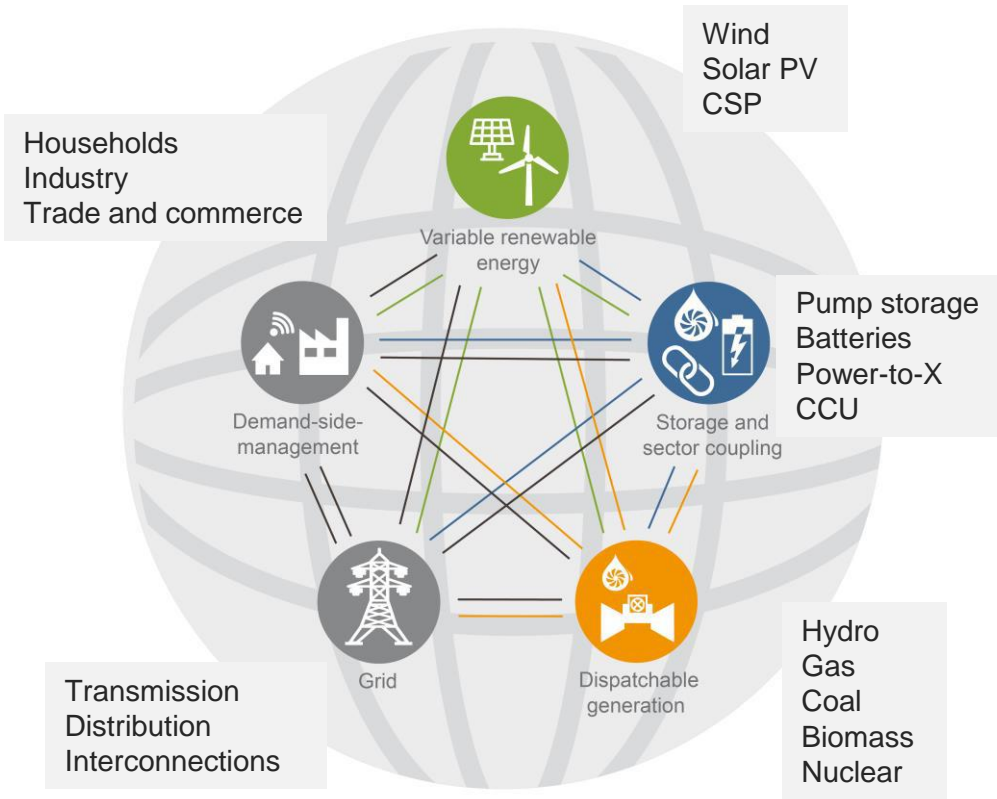

- Energy system flexibility becomes key
- Technologies become simpler, whereas the complete system becomes more complex → activities around system integration will play a greater role
- A balanced energy mix remains important: due to technical maturity of alternatives, dispatchable generation is currently the most important flexibility option in the energy system
- An overarching aspect of flexibility is the secure supply of energy covering the demand at any time

2. Global Flexibility Potential

Source: WEO 2018

2017

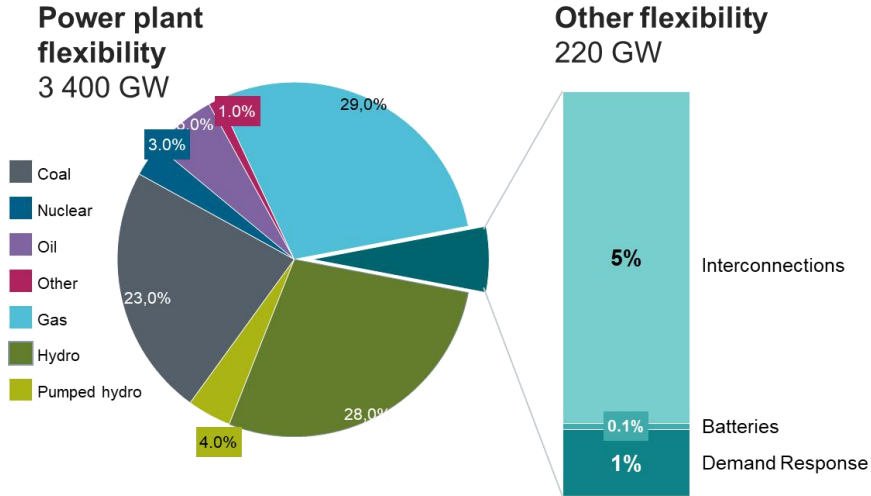

2040

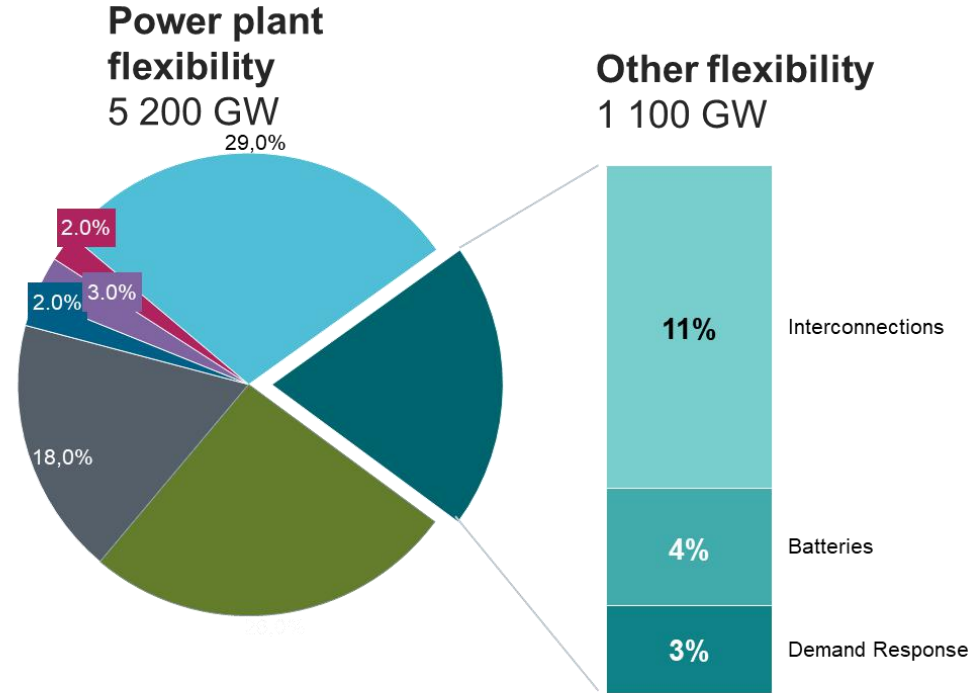

Dispatchable generation is and remains the most important flexibility option to offset the volatile characteristics of VRE. Development of alternative technology pathways is required.



- Facts and figures about flexibility provided by dispatchable generation
- Reports and publications as downloads available – e.g. “Flexibility Toolbox for coal-fired power plants“



1. About VGB
2. Major Trends in Global Energy Systems
3. **Status of Thermal Power Plants in Europe**
4. Flexibility through Sector Coupling
5. Conclusions

3. Europe's Energy Policy Targets



2030

- 55%** Greenhouse Gas Emission Reduction compared to 1990
- min 32 % Renewable Energy Consumption
- 32.5 % Increase of Energy Efficiency
- min 15% Interconnection



- Phase-out of Nuclear Power Plants in **2022**
- 65%** Share of Renewables in Electricity in **2030**
- 55%** Greenhouse Gas Emission Reduction until **2030** comp. to 1990
- Phase-out of Coal Power Plants until **2038** (*)

* Law in progress

A 55% reduction of greenhouse gases by 2030 is under discussion for the EU and in Germany.

3. European Power Generation in 2018

Gross power production: ~ 3.249 TWh

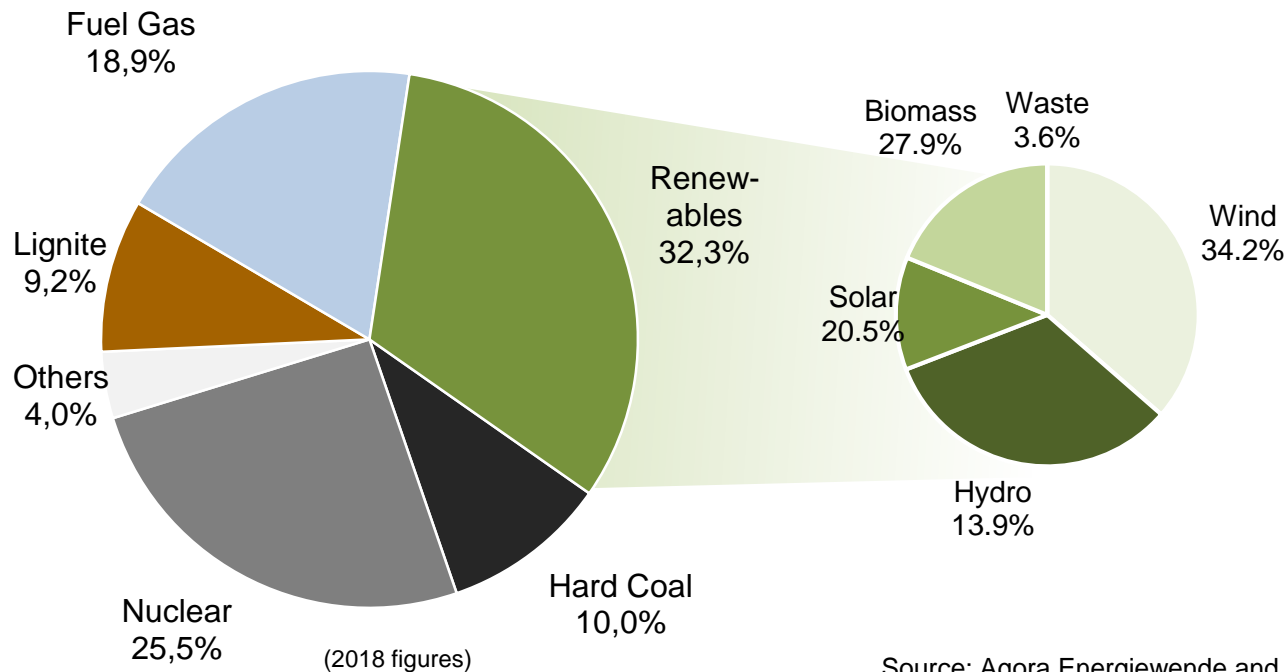

Source: Agora Energiewende and Sandbag (2018)

More than 50% of nearly unchanged RES is coming from volatile sources. Shift from gas to hydro. In 2019 large shift to gas foreseeable.

3. Coal phase-out in Europe has started

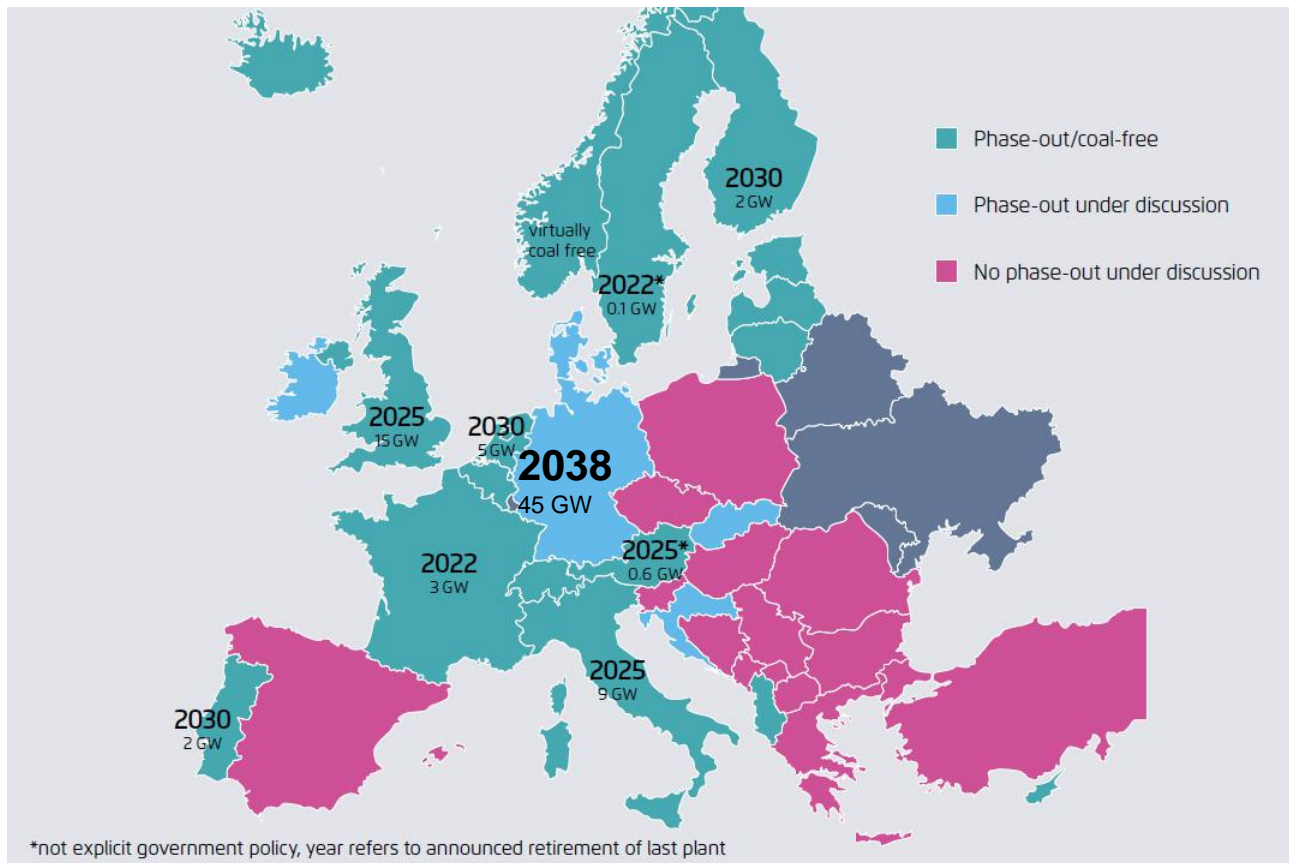

Political acceptance of coal based generation is falling rapidly. Pressure to change to gas and energy storage; push for sector coupling technologies.

Source: Agora Energiewende and Sandbag (2018)

3. Capacity Development in EU28

Source: WEO 2018

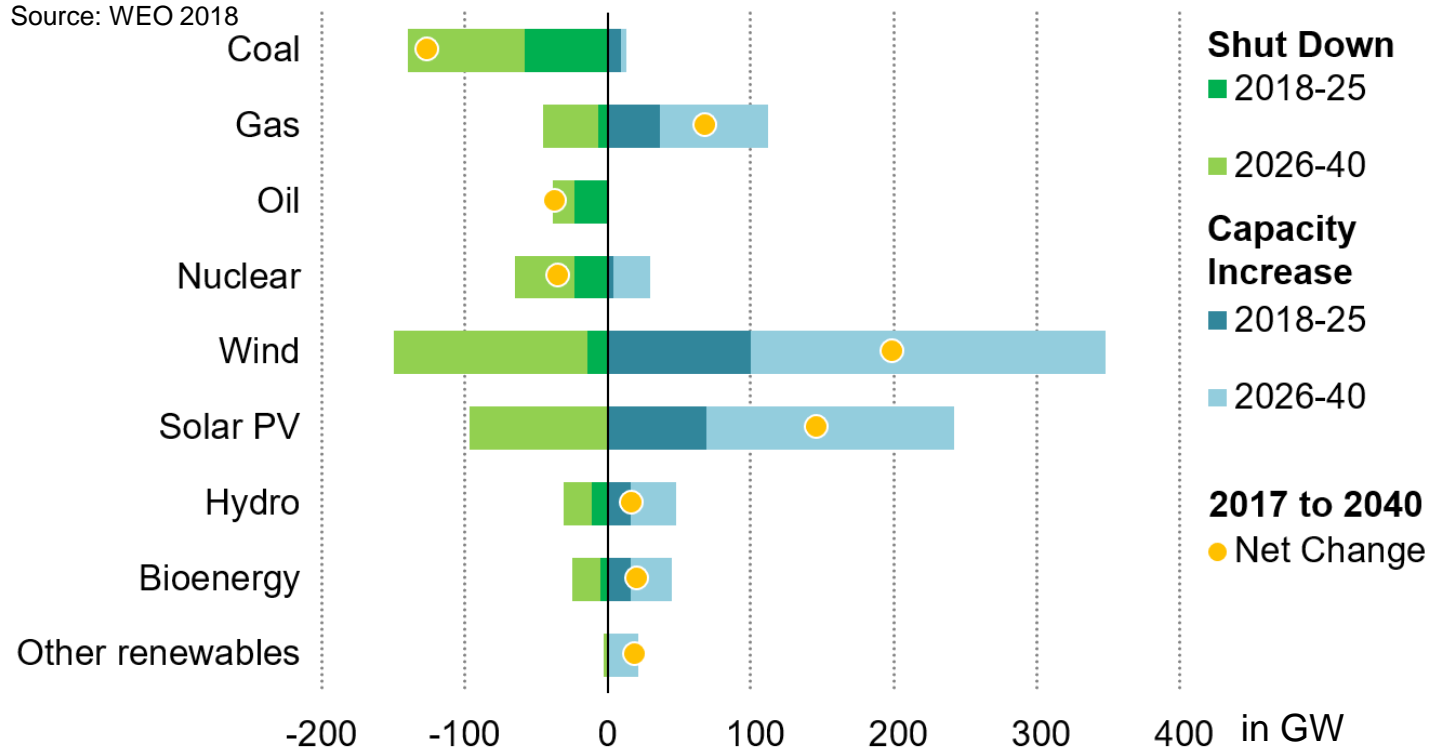

In the absence of commercially viable energy storage solutions dispatchable resp. secure generation capacity is essential to cover the European electricity demand (peak load is about 540 GW).



1. About VGB
2. Status of Thermal Power Plants in Europe
3. Major Trends in Global Energy Systems
4. **Flexibility through Sector Coupling**
5. Conclusions

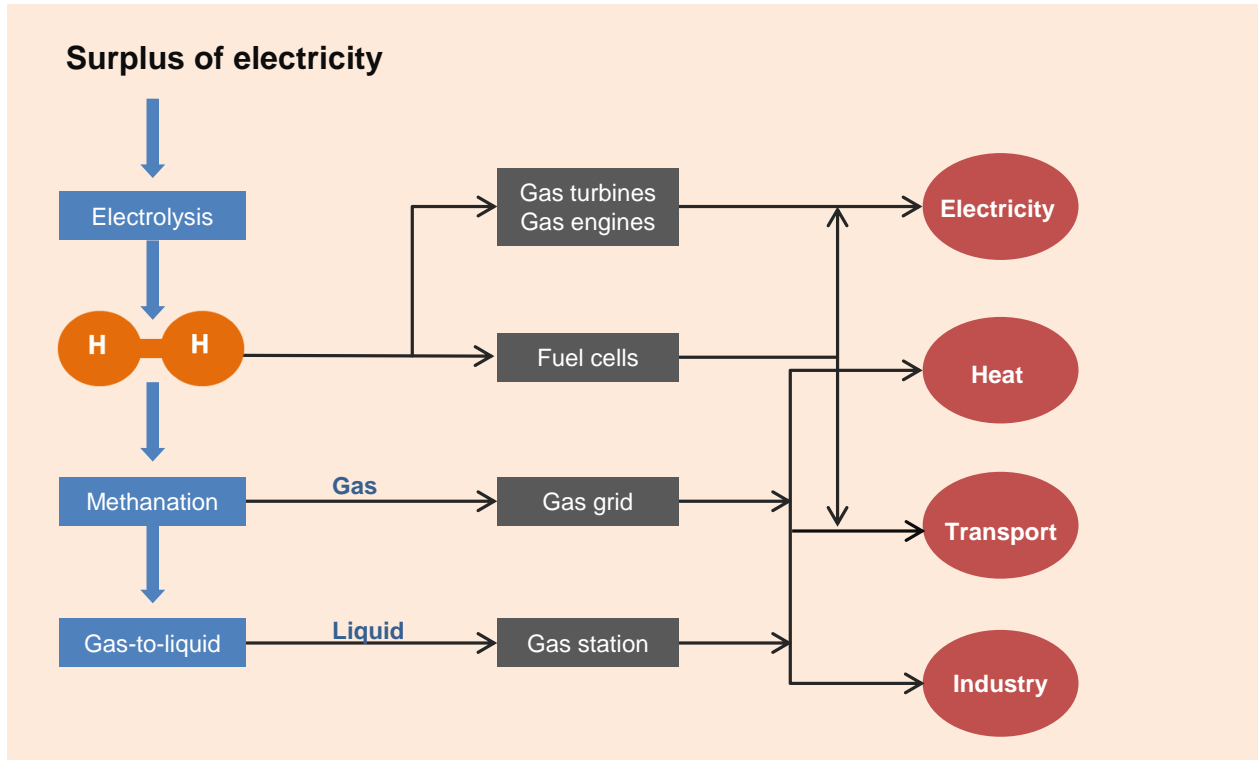

BMW initiated a competition of ideas for power-to-X plants:

- 20 project outlines were selected
- next step: realising these “Reallabore”

Basic processes for Power-to-x are well known. Key issues are large-scale commercial operation, flexibility and system integration.

4. Example B: Carbon Capture and Usage CCU, ALIGN 1/2

EU project: Accelerating Low Carbon Industrial Growth through CCUS

Source: Moser et.al., RWE and partners

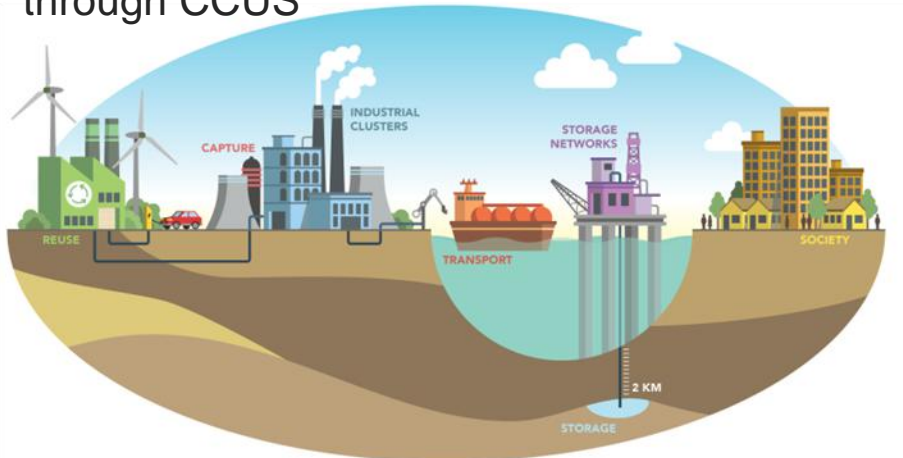
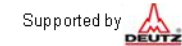

<p>WP1 CAPTURE</p> <ul style="list-style-type: none"> Emission control Solvent management Dynamics and control Cost reduction 	<p>WP2 TRANSPORT</p> <ul style="list-style-type: none"> CO₂ shipping Batch-wise injection CO₂ specifications Planning for flexible networks 	<p>WP3 STORAGE</p> <ul style="list-style-type: none"> Standardizing storage readiness North sea storage appraisals Re-use of existing assets 	<p>WPO MANAGEMENT</p>
<p>WP4 RE-USE</p> <ul style="list-style-type: none"> CCU demonstrator construction Engine adaption Operation and testing CCU integration and scale-up 	<p>WP5 INDUSTRIAL CLUSTERS</p> <ul style="list-style-type: none"> Teesside and Grangemouth (UK) Rotterdam (NL) North Rhine-Westphalia (DE) Grenland (NO) Oltenia region (RO) Commercial models for CCUS clusters 	<p>WP6 SOCIETY</p> <ul style="list-style-type: none"> Assessing public opinion Compensation strategies Improving EU dialogue on CCUS 	

- Support of the quick and cost-effective deployment of carbon capture, utilisation and storage in a holistic approach
- Enabling Europe’s industrial and power sectors to contribute to a low-carbon future while remaining economically viable
- ALIGN-CCUS unites 30 research institutes and industrial companies from 5 European countries (DE, NL, NO, RO, UK)

**WP4 “Re-Use“: Recycling of carbon
7 + 1 associated partner**



4. Example B: Carbon Capture and Usage CCU, ALIGN 2/2

Source: Moser et.al., RWE and partners

Sector coupling and carbon recycling - Chance of a smooth transition from „fossil“ to „renewable“ using existing infrastructure and avoiding disruptions

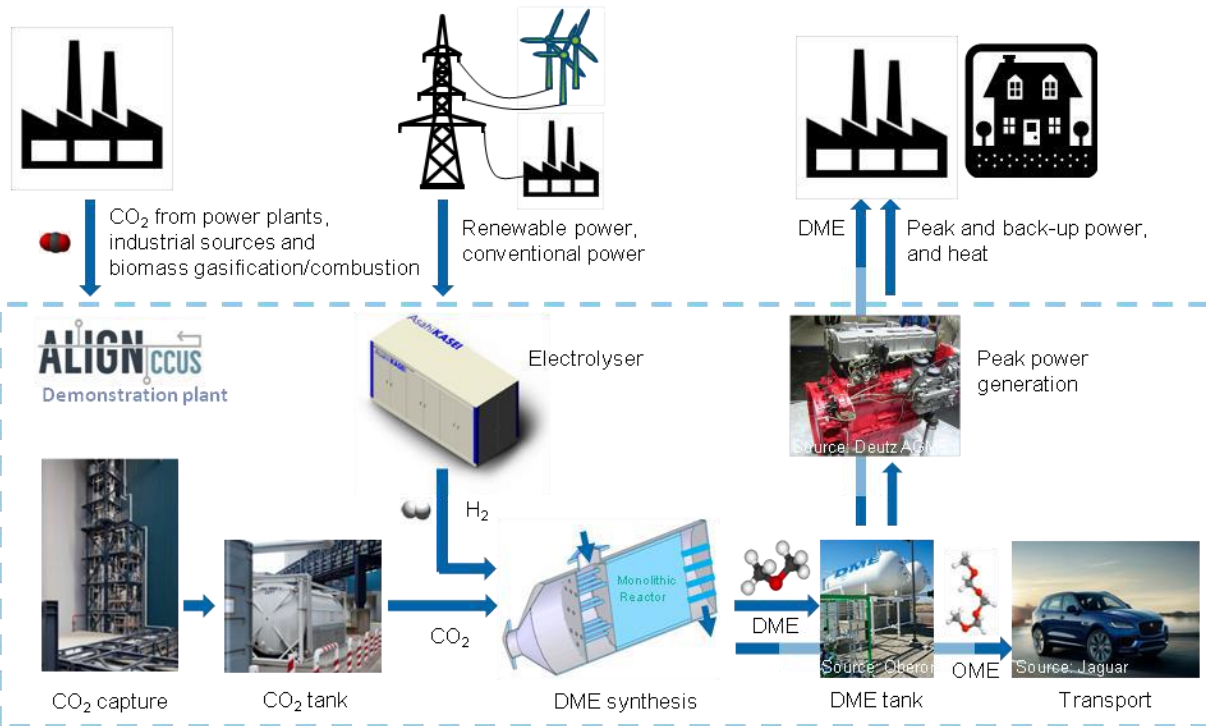

⇒ Sector coupling and CCU provide more than climate protection:

- Grid stability (long-term energy storage, peak power generation, back-up power)
- Process heat, heating fuels
- Feedstocks for chemical and petrochemical industry
- Supply of low-emission e-fuels (SO_x, NO_x, particulates, CO₂)

⇒ Synthetic fuels for back-up power and grid stability and greenhouse gas-reduced transport

4. Example C: Flexibilization through Thermal Storage FLEXITES

- Flexibilization of Power Plants by Thermal Energy Storages
- Integration into thermal coal-fired power plants
- Project duration: 2017 to 2019

Gefördert durch:



Bundesministerium für Wirtschaft und Energie

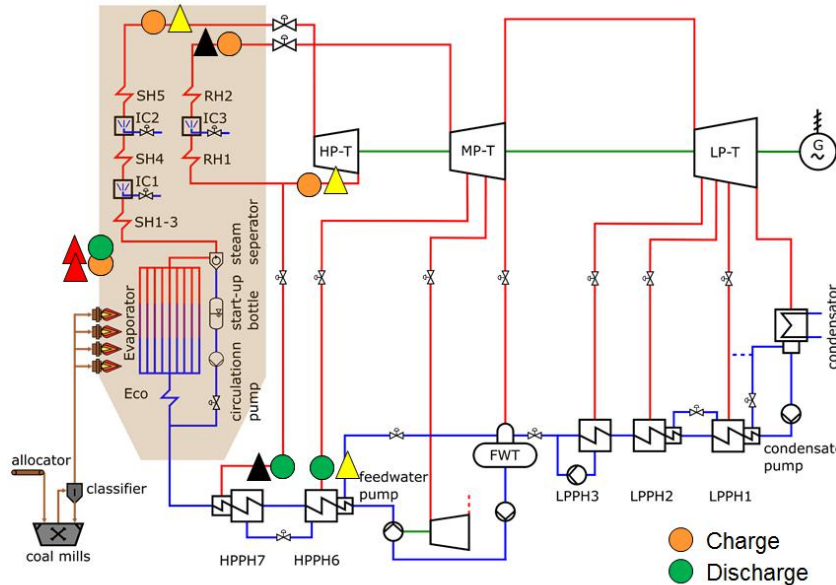

Lead concepts of thermal storage to increase operational flexibility as PP integrated system (Source: Siemens AG, LUAT, DLR)





1. About VGB
2. Status of Thermal Power Plants in Europe
3. Major Trends in Global Energy Systems
4. Flexibility through Sector Coupling
5. **Conclusions**

- Main pillars: variable generation from renewable sources, energy storage, sector coupling and dispatchable generation.
- Dispatchable generation is the most important flexibility option in the energy system for the foreseeable future.
- Supply security needs secure production capacity.
- A balanced energy mix remains significant, with a focus on low-carbon production.
- Required investments require stable regulatory frameworks (market design).



धन्यवाद

Thank you
for your interest!

Contact:

Dr. Oliver Then
Executive Managing Director
Deilbachtal 173

45257 Essen / Germany

Phone: +49 201 8128 250

Mobile: +49 160 8444 450

oliver.then@vgb.org

www.vgb.org

